

panel mounting socket outlet, straight - flange 75x75, fixing centers 60x60

Product description

Order number	13011
EAN/pcs	4024941130110
Product Group	GT panel mounting socket outlet straight
Amperage	32A
Poles	4p (3P+PE)
Earth 'Clock' Position	6 h
Voltage	380 up to 415V
Frequency	50 and 60Hz
Protection	IP44
Color code	red RAL 3000
Connection Design	screw terminal
Max. conductor	10,0 mm ²



Further Information

Material

Material of Enclosure	Polyamide
Contact / Contact Carrier	contact carrier made of polyamide, the contacts are brass
Weight/pcs	0.205 kg
Packaging unit	10 pcs

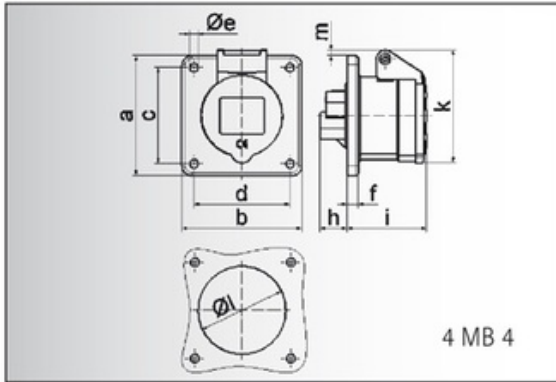

Ampere	16	16	16	32	32	32
Polzahl	3	4	5	3	4	5
a	75,0	75,0	75,0	75,0	75,0	75,0
b	75,0	75,0	75,0	75,0	75,0	75,0
c	60,0	60,0	60,0	60,0	60,0	60,0
d	60,0	60,0	60,0	60,0	60,0	60,0
e Ø	5,5	5,5	5,5	5,5	5,5	5,5
f	7,0	7,0	7,0	8,0	8,0	8,0
h	17,0	26,0	17,0	36,0	36,0	19,0
i	51,0	53,0	53,0	62,0	62,0	62,0
k	70,0	80,0	85,0	90,0	90,0	98,0
l Ø	45,0	45,0	55,0	60,0	60,0	60,0
m	3,5	7,0	11,5	12,0	12,0	17,0
Leiter mm ² min	1,5	1,5	1,5	2,5	2,5	2,5
Leiter mm ² max	4	4	4	10	10	10