

wall mounting socket outlet - housing dimensions 170x118

Product description

Order number	1124
EAN/pcs	4024941011242
Product Group	GT wall mounting socket outlet
Amperage	63A
Poles	5p (3p+N+PE)
Earth 'Clock' Position	6 h
Voltage	200/346 up to 240/415V
Frequency	50 and 60Hz
Protection	IP44
Color code	red RAL 3000
Connection Design	screw terminal as box terminal with Kontex-contact
Max. conductor	25.0 mm ²



Further Information

Cable entry	top entry M40 bottom entry M32
Packaging	170x118 mm (HxW)
Additional technical information	The cable entry is one at top open and two at bottom closed Lower part of housing rotatable by 180°

Material

Material of Enclosure	Polycarbonate
Contact / Contact Carrier	contact carrier made of Polyamide, contacts are brass nickel plated
Weight/pcs	0.830 kg
Packaging unit	5 pcs

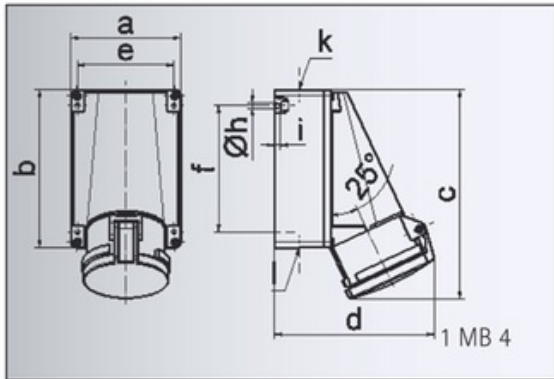

	63	63	63
Ampere	63	63	63
Polzahl	3	4	5
a	118,0	118,0	118,0
b	170,0	170,0	170,0
c	223,0	223,0	223,0
d	168,0	168,0	168,0
e	104,0	104,0	104,0
f	136,0	136,0	136,0
h ø	6,1	6,1	6,1
i	6,0	6,0	6,0
k	M 40	M 40	M 40
l	M 32/32	M 32/32	M 32/32
Leiter mm ² min	6	6	6
Leiter mm ² max	25	25	25